

KENWOOD

LCD COLOR MONITOR

KVX-5

INSTRUCTION MANUAL

KENWOOD CORPORATION

Safety Precautions

 **Caution:** Read this page carefully to ensure safe operation.

WARNING: TO PREVENT FIRE OR ELECTRIC SHOCK, DO NOT EXPOSE THIS APPLIANCE TO RAIN OR MOISTURE.

IMPORTANT SAFEGUARDS

Please read all of the safety and operating instructions before operating this unit. For best results, follow all warnings placed on the unit and adhere to the operating and use instructions. These safety and operating instructions should be retained for future reference.

1. **Power sources** — The unit should be connected to a power supply only of the type described in the operating instructions or as marked on the appliance.
2. **Power-cord protection** — Power-supply cords should be routed so that they are not likely to be walked on or pinched by items placed upon or against them. Pay particular attention to cords at plugs, convenience receptacles, and the point where they exit from the unit.
3. **Enclosure removal** — Never remove the enclosure. If the internal parts are touched accidentally, a serious electric shock might occur.
4. **Drop** — Do not drop the unit or apply strong shock to it. (Damage due to dropping the unit is not covered by the warranty.)
5. **Ventilation** — Avoid hindering the ventilation of the unit by covering it with a cloth, etc.
6. **Abnormal smell** — If an abnormal smell or smoke is detected, immediately turn the power OFF and pull out the power cord. Contact your dealer or nearest service center.
7. **Heat** — Avoid placing the unit under direct sunlight or near a source of heat such as heating equipment.
8. **Temperature** — The unit may not function properly if used at extremely low, or freezing temperatures. The ideal ambient temperature is above +5°C (41°F).
9. **Water and moisture** — The unit should not be used near water — for example, near a bathtub, washbowl, kitchen sink, laundry tub, in a wet basement, or near a swimming pool, etc.
10. **Dust and moisture** — Avoid places where is dusty or where the humidity is high.
11. **Vibrations** — Avoid placing the unit on an unstable place such as a shelf or in a place subject to vibrations.
12. **Magnetic fields** — Keep the unit away from sources of magnetic fields such as TV sets, speaker systems, radios, motorized toys or magnetized objects.
13. **Handling of the LCD Panel**
 - Do not scratch the LCD panel, apply a strong pushing force to it or subject it to strong impacts. Doing so could cause damage to the panel.
 - If the LCD panel is broken, do not touch the liquid inside the panel. If this liquid gets in your eyes or mouth, or gets on the skin, rinse thoroughly with water and consult your physician.
14. **About the Unit's Stand**
 - Do not apply strong force when opening the stand. Doing so could damage the stand.
 - The stand could be damaged if a strong pushing force is applied to unit when the stand is in use. Be careful not to apply a strong force to the unit.
15. **Cleaning** — Do not use volatile solvents such as alcohol, paint thinner, gasoline, or benzine, etc. to clean the cabinet. Use a clean dry cloth.
16. **Nonuse periods** — The power cord of the unit should be unplugged from the outlet when left unused for a long period of time.
17. **Damage requiring service** — The unit should be serviced by qualified service personnel when:
 - A. The power-supply cord or the plug has been damaged.
 - B. Objects have fallen, or liquid has been spilled into the unit.
 - C. The unit has been exposed to rain.
 - D. The unit does not appear to operate normally or exhibits a marked change in performance.
 - E. The unit has been dropped, or the enclosure damaged.
18. **Serviceing** — The user should not attempt to service the unit beyond that described in the operating instructions. All other servicing should be referred to qualified service personnel.
19. **CAUTION** — TO PREVENT ELECTRIC SHOCK DO NOT USE THE AC PLUG WITH AN EXTENSION CORD, RECEPTACLE OR OTHER OUTLET UNLESS THE BLADES CAN BE FULLY INSERTED TO PREVENT BLADE EXPOSURE.

Before Applying Power



 **Caution:** Read this page carefully to ensure safe operation.

AC adaptors are designed for operation as follows.

Europe and U.K. AC 230 V only

Contents

Caution: Read the pages marked  carefully to ensure safe operation.

 Safety Precautions	2
 Before Applying Power	3
Introduction	4
Checking the Accessories	4
Using the Stand	4
Connections	5
Connecting the Power Supply (AC adaptor)	5
Connecting AV Equipment	5
Name and Function of Parts	6
Setting the Menu	7
Selecting Menu Items	7
Setting Menu	7
Selecting the Color System (MODE)	8
Setting COLOR/TINT/PICTURE	8
Initial Resetting	8
Selecting AV Input	9
Adjusting the Sound Volume	9
Adjusting the Brightness of the Screen	10
Listening to Sounds with Headphones	10
Troubleshooting Problems	11
Specifications	Back cover

Introduction

Keep the packing case for later usage, e.g., protection of your system in transportation for repair services and so on.

Checking the Accessories

Check the accessories as specified below:

AC adaptor (1 set)

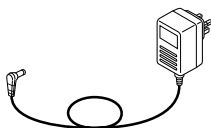

AV cable (1 piece)

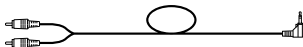

Cushion (2 pieces)

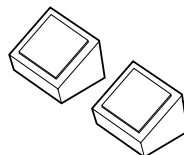

Using the Stand

You can incline your system using the stand on the rear when looking at the screen.

Slowly pull out the stand until it stops.

Note: When pulling the stand out, do not apply an excessive force to it. A strong force can cause stand breakage.

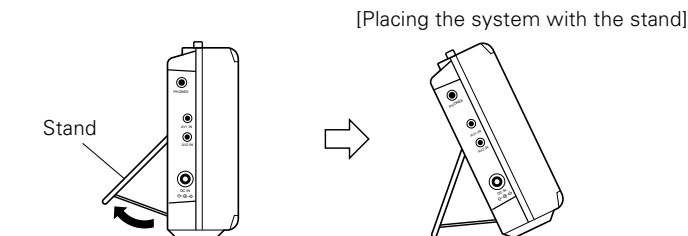

To make the TV more stable during use

When setting up the stand, make it more stable during use by affixing the cushion supplied to the bottom of the set.

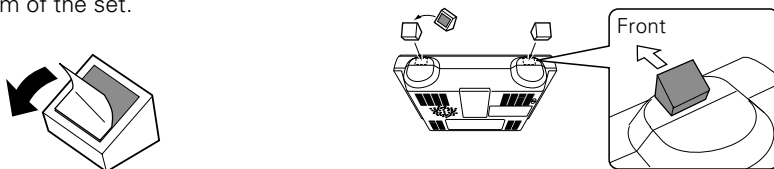

1 Peel the seals off the double sided tape affixed to the cushion.

2 Affix the cushion to the TV body.

Connections

Connecting the Power Supply (AC adaptor)

Plug the AC adaptor into the AC outlet.

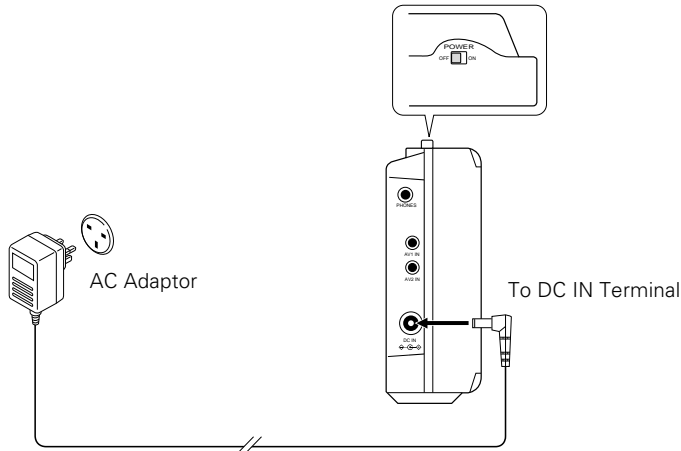

Note: Be sure the POWER switch is set to the OFF position before you connect the AC adaptor. Connecting the AC adaptor with the POWER switch set to the ON position may cause a trouble in the system.

Connecting AV Equipment

This system is equipped with the two AV input terminals: AV1 IN and AV2 IN.

Use the AV cable supplied with your system for connection between external AV equipment and the AV1 IN terminal or AV2 IN terminal of the system.

- Plug the video terminal of the AV cable (yellow) into a video output terminal of AV equipment and plug the audio terminal (white) into audio output terminal L or R of the AV equipment.

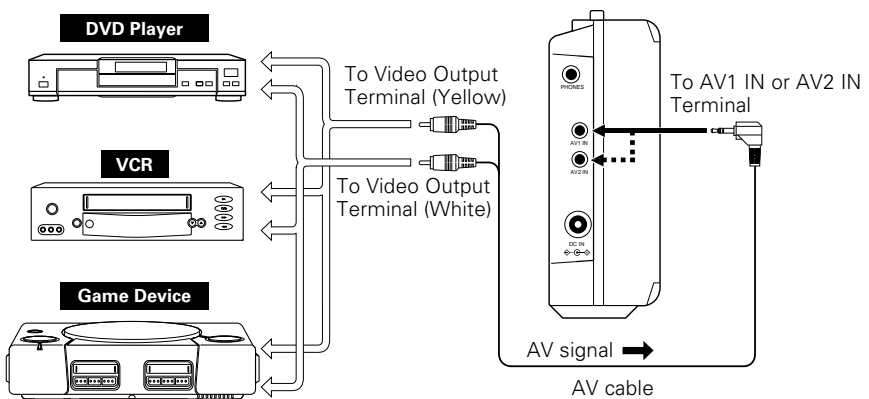

Name and Function of Parts

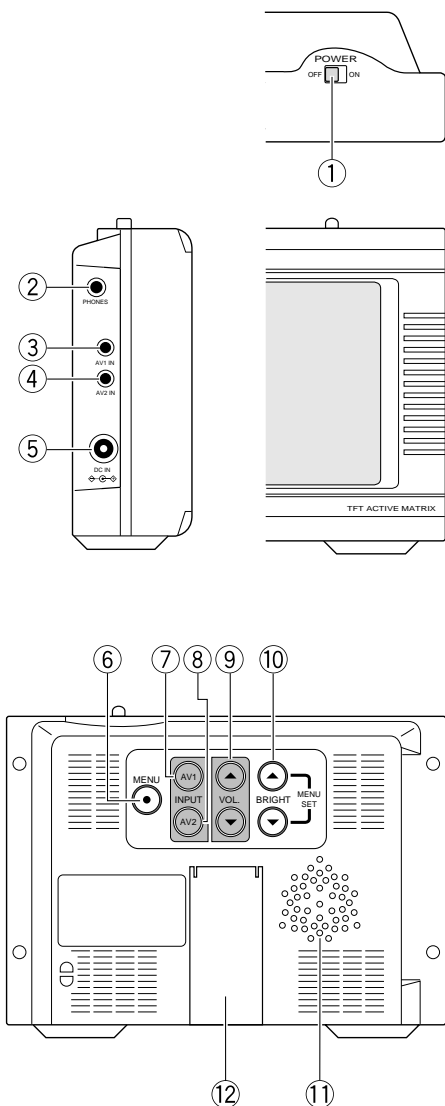

- 1 **POWER switch**
Turns on or off the power of the system.
- 2 **PHONES terminal**
Connects headphones. (Page 10)
 - No sound will be emitted from the speaker.
- 3 **AV1 IN terminal**
Inputs audio/video signals from external AV equipment. (Page 5)
- 4 **AV2 IN terminal**
Inputs audio/video signals from external AV equipment. (Page 5)
- 5 **DC IN terminal**
Connects the AC adaptor. (Page 5)
- 6 **MENU button**
Displays menu on the screen, allowing you to select items on the menu. (Page 7)
- 7 **AV1 button**
Selects the input signal of the AV1 IN terminal. (Page 9)
- 8 **AV2 button**
Selects the input signal of the AV2 IN terminal. (Page 9)
- 9 **VOL. ▲/▼ button**
Adjusts the sound volume. (Page 9)
 - Pressing the buttons at a time displays "MUTE" at the bottom of the screen, muting sound. Pressing the VOL. ▲ or ▼ button releases the system from muting. (Page 9)
- 0 **BRIGHT ▲/▼ button**
Adjusts the brightness of the screen. (Page 10)

In the menu display mode, the button functions as the MENU SET ▲/▼ button, allowing you to set menus. (Page 7)
- **Speaker**
A built-in monaural speaker.
- = **Stand**
Is pulled out to incline the system. (Page 4)

Setting the Menu

Pressing the MENU button displays the following menu on the screen.

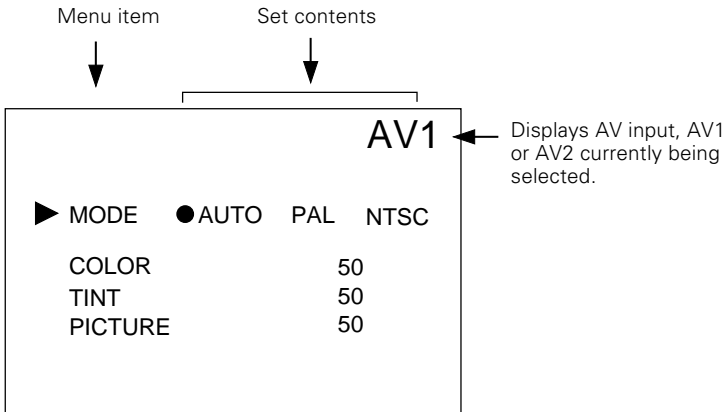

Note: The contents set up just before the power was turned off appears on the screen. The screen above is an image that appears when you purchased the system.

Selecting Menu Items

The arrow (▶) shows a menu item currently being selected. Each time you press the MENU button, you can select the menu items in the following order.

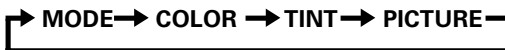

Setting Menu

The bullet (●) at menu item "MODE" indicates a menu currently being selected. For other menu items, the current settings are given in numeric values. Each time you press the MENU SET ▲/▼ button when the menu screen appears, change is made to the setup contents of a menu item currently being selected.

Setting the Menu (Continued)

Selecting the Color System (MODE)

You can select one of the following modes for the Color system.

AUTO: Automatically selects PAL or NTSC according to the video signal received.

PAL: Sets PAL for the Color system.

NTSC: Sets NTSC for the Color system.

- 1 Press the MENU button to select "MODE".**
- 2 Press the MENU SET ▲/▼ button to select the Color system.**
Each time you press the button, the setting changes as follows:

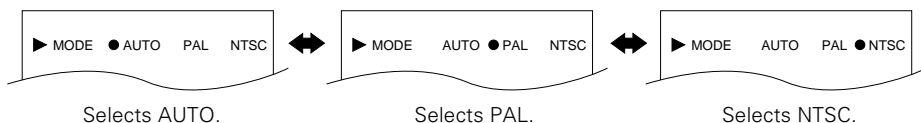

Setting COLOR/TINT/PICTURE

You can make the following adjustments in each menu item.

COLOR: Depth of color

TINT: Tint

PICTURE: Picture quality

- 1 Press the MENU button and select "COLOR", "TINT" or "PICTURE".**
- 2 Press the MENU SET ▲/▼ button to adjust each of them.**
Each time you press the button, the value changes in the range 0 to 100.

[Color adjustment sample]

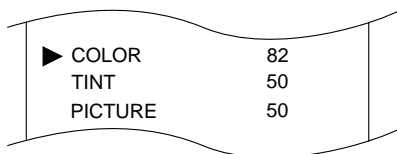

Initial Resetting

You can get the menu settings back to state at the time you purchased the system.

While pressing the MENU button, turn on the POWER switch.



Selecting AV Input

Select either one of the two AV inputs by using the AV1 or AV2 button. Turning on the power selects the AV input selected just before the power was turned off.

- Pressing the AV1 button displays “AV1” at the upper right portion of the screen for several seconds, receiving AV signals from AV equipment connected to the AV1 terminal.
- Pressing the AV2 button displays “AV2” at the upper right portion of the screen for several seconds, receiving AV signals from AV equipment connected to the AV2 terminal.

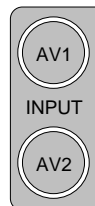

[When the AV1 button is pressed]



[When the AV2 button is pressed]



Note: If a selected AV input terminal does not receive video signals, “NO SIGNAL” appears at the bottom of the screen.

Adjusting the Sound Volume

Press the VOL. ▲/▼ button to adjust the sound volume.

Adjustment values appear on the screen during adjustment.

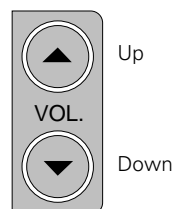
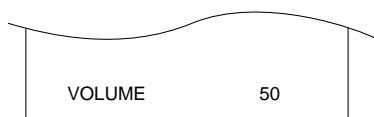

Muting Sounds:

Pressing the VOL. ▲ and ▼ buttons at a time mutes sounds. “MUTE” appears on the screen in red.

- Pressing either VOL. ▲ or ▼ button releases the system from muting. Turning off the power also releases the system from muting.

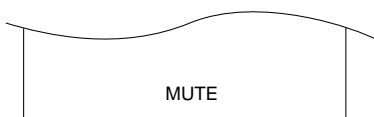

Adjusting the Brightness of the Screen

Press the **BRIGHT ▲/▼** button to adjust the brightness of the screen.

An numerical adjustment value (0~100) is displayed on the screen during adjustment.

Note: The brightness of the screen differs depending on the angle at which you see the liquid crystal panel. So, adjust the brightness of the screen after setting the watching angle.



Listening to Sounds with Headphones

You can listen to sounds with monaural headphones plugged into the system.

Stereo headphones are also available. However, you will hear monaural sounds even with stereo headphones.

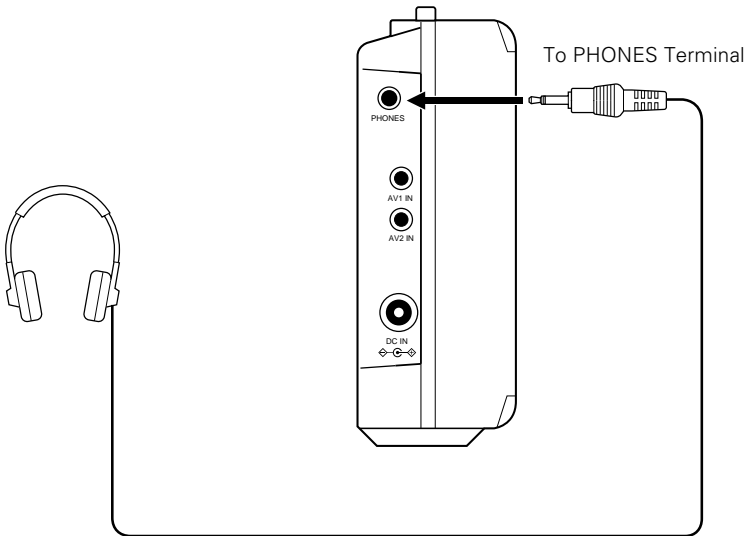

Note: When you use headphones, no sound will be emitted from the speaker.

Troubleshooting Problems

If the system does not work as you expect, perform the following checks before contacting Customer Support.

Problem	Action to be taken
No image and no sound	<ul style="list-style-type: none"> • Check the AC adaptor for proper connection. • Check that the POWER switch is turned on. • Check that the brightness and volume are minimized or the system is put in mute state.
No image and no sound (“NO SIGNAL” appears)	<ul style="list-style-type: none"> • Check the selected AV input (AV1 or AV2) for connection to AV equipment. • Check for reception of audio/video signals from AV equipment.
No image, or black or white screen	<ul style="list-style-type: none"> • Check the brightness for maximum or minimum.
No Sound	<ul style="list-style-type: none"> • Check the sound volume for minimum or check the system for being put in mute state. • Check headphones for being plugged into the system.
<ul style="list-style-type: none"> • Poor-quality image displayed • Image doubly displayed • Image fading • Image swaying • Stripes and patterns 	<ul style="list-style-type: none"> • Check for reception of radio interference from other equipment, etc. (Turn off the power of other equipment.)
Inappropriate color or light color	<ul style="list-style-type: none"> • Check COLOR, TINT, and PICTURE for proper adjustment.
Dark screen	<ul style="list-style-type: none"> • Check the direction of the crystal liquid panel for proper adjustment. • Check the brightness for proper adjustment.
Dark screen in the initial stage	<ul style="list-style-type: none"> • When the temperature of the system is low, the screen becomes darker than usual just after the power is turned on because of the characteristic of the liquid crystal panel. Wait for a while until the temperature goes up. The screen will get light as usual.

- If this product interferes with radio reception during use, place it far enough away from the radio to eliminate the interference.

Specifications

Model Designation	5.6-inch LCD Color Monitor K VX-5
Maximum external dimensions	Width: 180 mm (7-1/16") Height: 136 mm (5-3/8") Depth: 55 mm (2-3/16")
Weight (net)	620 g (1.4 lb)
AC adaptor	DC 12 V
Liquid Crystal Panel	High-resolution 5.6-inch color LCD
Driving System	TFT active matrix system
Light Source	Backlight: High intensity fluorescent tube
Color System	PAL/NTSC
Speaker	3.5-cm round type speaker with 500 mW output

- These ratings and the design are subject to change without notice for technical development.
- Lack of picture elements in part may occur in the liquid crystal panel or some picture elements may be lit abnormally.

KENWOOD

For your records

Record the serial number, found on the back of the unit, in the spaces designated on the warranty card, and in the space provided below. Refer to the model and serial numbers whenever you call upon your dealer for information or service on this product.

Model _____

Serial Number _____